



Gebrauchsanweisung Mode d'emploi • Instruction Manual



Gebrauchsanweisung

Mode d'emploi • Instruction manual

Deutsch

Guten Tag	3
Montage / Aufbau	4
Raclettezubereitung	6
Unsere klassischen Geräte...	8
Raclette easy	10
Raclette accessoires...	11
Sicherheitshinweise	12

English

Hello	23
Assembly / Set-up	24
Preparing the Raclette	26
Our classic appliances...	28
Raclette easy	30
Raclette accessories...	31
Safety Instructions	32

Français

Bonjour	13
Montage	14
Préparation de la raclette	16
Nos appareils classiques...	18
Raclette easy	20
Accessoires pour la raclette...	21
Prescriptions de sécurité	22

Garantie/Warranty

35

Guten Tag

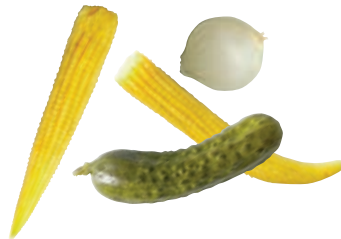

Raclette ist ein altes Bauernrezept aus den Walliser Bergen, mit Gluthitze gegrillter Alpenkäse, ein Leckerbissen. Heute, mit Hilfe eines TTM-Raclette-Ofens, ist klassisches Raclette für jedermann schnell und einfach zuzubereiten.

Sie benützen dazu, je nach Grösse der Tafelrunde, einen oder zwei halbe Laibe Raclette-Käse. Die Schnittfläche wird unter die Hitze gehalten, bis die Masse zu schmelzen beginnt. Das Geschmolzene wird dann direkt auf einen Teller abgestrichen und mit Pellkartoffeln, Silberzwiebeln und Essiggurken serviert. Eine kräftige Prise gemahlener Pfeffer gehört als Krönung über jedes Raclette, von jedem Tischgenossen natürlich selber aufgestreut.

Traditionsgemäss fängt jeder sofort zu essen an, solange der Käse warm ist, und wartet nicht, bis alle bedient sind. Begleiten Sie dieses köstliche Mahl mit einem edlen, trockenen Weisswein. Nach altem Brauch ist es der Hausherr, der die Raclettes macht und in die einzelnen Teller abstreicht.



Guten Appetit!

Montage/Aufbau

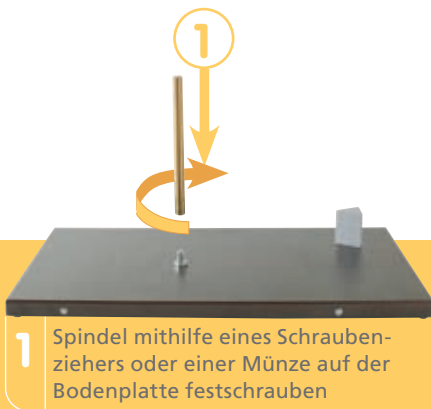

Reinigung

Nur mit feuchtem Tuch reinigen. Gerät nach der Reinigung trockenreiben. Die Metallteile nie ins Wasser tauchen.

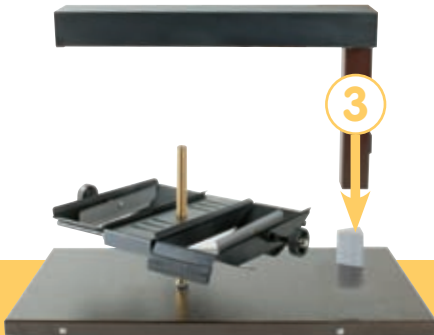

- 3** Den Heizarm mit Kolonne auf den Aluminiumbolzen stecken.



- 4** Den Heizarm mit der Rändelschraube fixieren, dann Stromkabel einsetzen. Bei der ersten Inbetriebnahme kann leichter Rauch entstehen. Dies ist normal und bedeutet keine Gefahr.

Schwarze Metallteile ab und zu mit Speiseöl leicht einölen.

Raclette-Zubereitung



1 Falls nötig, die Käserinde durch leichtes Schaben reinigen (nicht wegschneiden!).



2 Käseleib auf Käsehalter legen.

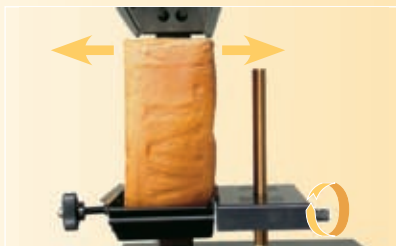

5 Käsehalter mittels Rändelschraube zentral unter der Heizung positionieren.



6 Käsehalter um die Spindel drehen.



3 Käselaub festspannen.

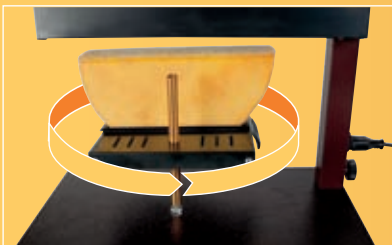

4 Käse nach oben zum Heizkörper drehen (Abstand 2cm). Einschalten: Schalter auf 1 oder Kabel einstecken.



7 Käse in Schräglage heben und mit Raclettemesser (glatte Seite) auf Teller abstreichen.

Tipps

Nach jeweils 4-5 Raclettes verbleibt an den Rändern eine gegrillte Kruste. Diese feine Kruste mit der gezackten Seite des Raclettemessers abschneiden und zusammen mit einer Raclette servieren (sie heisst „raclette religieuse“, denn sie schmeckt himmlisch!). Übrigbleibender Käse einfrieren oder für Gratins, belegte Brote oder Käseschnitten verwenden. Grosse Reste halten sich bis 8 Wochen im Kühlschrank, kleine 2–3 Wochen.



Unsere klassischen Geräte...

	Party	Party Caro	Racletta
			
Käse	¼ rund	¼ eckig	⅓ eckig
Leistung	600W	600W	600W
On-off-Schalter	nein	ja	nein
Schwenkarm	ja	nein	Ja

	Super	Evolène «Top range»-Modell
		
Käse	2 x ½ rund und eckig	2 x ½ rund und eckig
Leistung	1000W	2 x 1000W
On-off-Schalter	ja	2 x (1 pro Heizung)
Schwenkarm	ja	2 x (1 pro Käse)

Ambiance	POP	Zinal «Top range»-Modell	DS 2000
			
½ rund und eckig	½ rund und eckig	½ rund und eckig	2 x ½ rund und eckig
1000W	1000W	1000W	1000W
ja	nein	ja	ja
nein	ja	ja	nein

Trio	Gas-Geräte		
	Easy-Gaz	Brio-Gaz	Balthasar
			
3 x ½ rund	½ rund und eckig	2 x ½ rund und eckig	½ rund und eckig
2 x 1000W	1.9 – 2.5 kW	2.6 – 3.4 kW	2.6 – 3.4 kW
2 x (1 pro Heizung)	nein	nein	nein
nein	nein	ja	ja

Raclette easy (ohne Strom und Gas)

	Twiny Cheese rot	Twiny Cheese schwarz	Twiny Cheese inox
			
Heizkörper	6 Kerzen	6 Kerzen	6 Kerzen
Artikel-Nr.	Art. 100.024	Art. 100.025	Art. 100.029





	Pico	Racly	Raclette à deux
			
Heizkörper	3 Kerzen	1 Pastenbrenner	2 Pastenbrenner
Artikel-Nr.	Art. 100.033	Art. 100.021	Art. 100.026

Raclette accessoires...

Profi	Chef	Support inox	Griff Käsehalter
			
Abstreichmesser	mit Antihaft-Beschichtung	Lange Auflage für eckigen Käse	Hitzeschutz aus Kautschuk
Art. 800.001	Art. 800.071	Art. 102.1032	Art. 102.065

Käsehalter ½ Käse (rund und eckig)	Käsehalter 2 x ½ Käse (rund und eckig)	Kartoffelgabel	Kartoffelwarmhalter Brienz
			
Mit Antihaft-Beschichtung	Mit Antihaft-Beschichtung		
Art. 101.052.1	Art. 101.101.1	Art. 800.070	Art. 800.068

Sicherheitshinweise

	Nie mit Wasser oder anderen Flüssigkeiten in Berührung bringen. Kurzschlussgefahr!
	Nur auf standsichere Abstellflächen legen. Mindestabstand zur Wand 30 cm.
	Das Gerät nicht ohne Käse in Betrieb lassen • Nie in der Nähe von leicht entzündbaren Materialien benützen • Kinder dürfen das Gerät nicht bedienen • Auch bei kurzen Unterbrüchen der Käseerhitzung das Gerät ausschalten • Ohne Käse Käsehalterung und Feststellräder immer ausserhalb Strahlungsquelle positionieren • Gerät nie auf leicht brennbare Unterlagen stellen (Papiertischtücher etc.) • Spindel und Oberteil des Heizkörpers werden heiss • Nie von unten in den Heizkörper fassen • Nach Ausschalten 20 min lang nicht anfassen • Ohne Käse erhitzt sich der Boden des Gerätes und die darunterliegende Aufstellfläche stark: keine brennbaren Materialien drauflegen
	Entsorgung: Das Netzkabel muss vom Gerät getrennt werden. Bestimmungen der Wohngemeinde beachten.

Bonjour

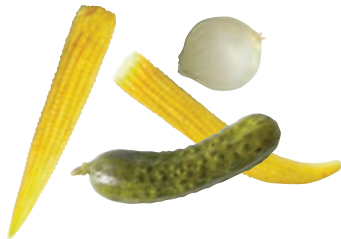

La raclette est une vieille recette paysanne du Valais faite à base de fromage grillé au feu de bois. Un vrai régal! Aujourd'hui, grâce aux appareils TTM, la raclette traditionnelle est à la portée de tous, aisément et rapidement.

Prenez une ou deux demi-meules de fromage à raclette selon le nombre de convives. Placez la demi-meule sous la source de chaleur, jusqu'au moment où elle commence à fondre. Raclez cette masse fondue directement sur une assiette et servez-la accompagnée de pommes de terre, d'oignons et de cornichons. Assaisonner à votre appréciation avec du poivre moulu pour atteindre des sommets culinaires.

La raclette doit être mangée chaude, sans attendre que tout le monde soit servi. Accompagnez ce délicieux repas avec un vin blanc fin. Suivant une coutume ancestrale, il appartient au maître des lieux de préparer et de servir la raclette.



Bon appétit !

Montage

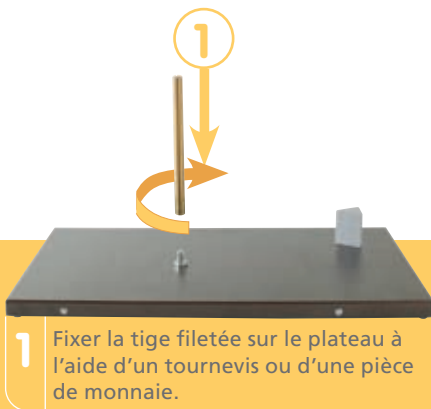

Nettoyage

Nettoyer uniquement avec un chiffon humide. Bien essuyer ensuite. Les parties métalliques ne doivent jamais être trempées dans l'eau.

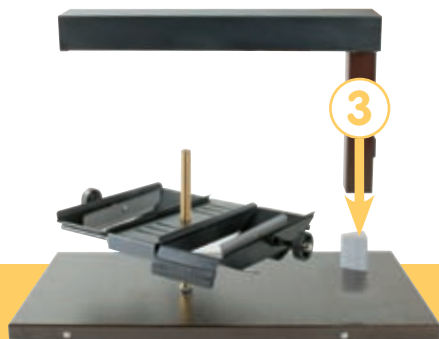

3 Emboîter le bras chauffant sur le triangle en aluminium du plateau.



4 Fixer le bras chauffant à l'aide de la molette, brancher ensuite le cordon électrique. Lors de la première utilisation de l'appareil, une légère fumée peut se dégager. Cela est normal et sans danger.

De temps en temps, huiler légèrement les parties métalliques noires avec de l'huile comestible.

Préparation de la raclette



1 Si nécessaire, nettoyer la croûte en la grattant légèrement (sans la couper !).



2 Poser le fromage sur le support.

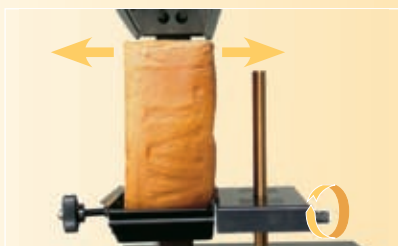

5 Positionner le porte-fromage au centre sous le corps de chauffe au moyen de la petite vis moletée



6 Tourner le porte-fromage autour de la tige filetée.



3 Serrer la meule de fromage.

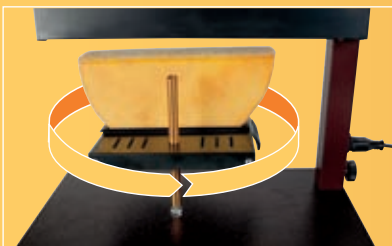

4 Faire monter le fromage sous le corps de chauffe (à 2cm). Enclencher : interrupteur sur 1 ou brancher le cordon.





7 Incliner le fromage et racler dans l'assiette (côté lisse du couteau).



Tipp



Après 4-5 raclettes, une croûte grillée se forme sur les bords du fromage. Couper cette fine croûte (côté micro-denté du couteau) et la servir avec une raclette (elle se nomme « raclette religieuse », car elle est divinement savoureuse !). Congeler le fromage restant ou l'utiliser pour des gratins, des tranches au fromage ou le manger froid. Les grands morceaux se conservent au réfrigérateur jusqu'à 8 semaines, les plus petits 2 à 3 semaines.



Nos appareils classiques...

	Party	Party Caro	Racletta
			
Fromage	¼ rond	¼ carré	⅛ carré
Puissance	600W	600W	600W
Interrupteur on-off	non	oui	non
Bras pivotant	oui	non	oui

	Super	Evolène modèle « Top range »
		
Fromage	2 x ½ rond et carré	2 x ½ rond et carré
Puissance	1000W	2 x 1000W
Interrupteur on-off	oui	2 x (1 par chauffage)
Bras pivotant	oui	2 x (1 par fromage)

Ambiance	POP	Zinal modèle « Top range »	DS 2000
			
½ carré et rond	½ carré et rond	½ carré et rond	2 x ½ rond et carré
1000W	1000W	1000W	1000W
oui	non	oui	oui
non	oui	oui	non

Trio	Appareils à gaz		
	Easy-Gaz	Brio-Gaz	Balthasar
			
3 x ½ rond	½ rond et carré	2 x ½ rond et carré	½ rond et carré
2 x 1000W	1.9 – 2.5 kW	2.6 – 3.4 kW	2.6 – 3.4 kW
2 x (1 par chauffage)	non	non	non
non	non	oui	oui





Raclette easy (sans gaz ni électricité)

	Twiny Cheese rouge	Twiny Cheese noir	Twiny Cheese inox
			
Chauffage	6 bougies	6 bougies	6 bougies
Numéro d'article	100.024	100.025	100.029

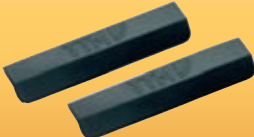

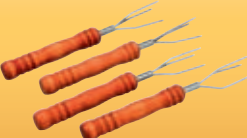

	Pico	Racly	Raclette à deux
			
Chauffage	3 bougies	1 brûleur à pâte	2 brûleurs à pâte
Numéro d'article	100.033	100.021	100.026

Accessoires pour la raclette...

Profi	Chef	Support inox	Poignée porte-fromage
			
Couteau à raclette	Avec revêtement anti-adhésif	Support long pour fromage carré	Protection chaleur en caoutchouc
800.001	800.071	102.1032	102.065

Porte-fromage ½ meule (rond et carré)	Porte-fromage pour 2 x ½ meule (rond et carré)	Fourchettes	Brienz
			
Avec revêtement anti-adhérent	Avec revêtement anti-adhérent	4 fourchettes à 3 piques	Pour maintenir au chaud des patates
101.052.1	101.101.1	800.070	800.068

Prescriptions de sécurité

	L'appareil ne doit jamais entrer en contact avec de l'eau ou avec tout autre liquide: Danger de court-circuit!
	Ne posez l'appareil que sur une surface plane et stable. Distance minimale entre l'appareil et une paroi : 30 cm.
	Ne jamais utiliser l'appareil sans fromage • Ne jamais utiliser l'appareil à proximité de matériaux inflammables • Les enfants ne doivent pas utiliser l'appareil • En cas d'interruption dans la préparation de la raclette, l'appareil doit être débranché • Sans fromage, veiller à éloigner la molette du dispositif de serrage de la source du rayonnement • Ne jamais poser l'appareil sur un support légèrement inflammable (nappes en papier, etc.) • La tige filetée et la partie supérieure du corps de chauffe deviennent chaudes • Ne jamais se saisir de l'appareil en le prenant sous le corps de chauffe • Ne pas se saisir de l'appareil, une fois débranché, avant 20 minutes • Le plateau et la partie située au-dessous de l'appareil chauffent fortement sans la présence d'un fromage : ne pas y poser du matériel inflammable.
	Recyclage : Le câble doit être séparé de l'appareil. Observer les prescriptions en vigueur.

Hello

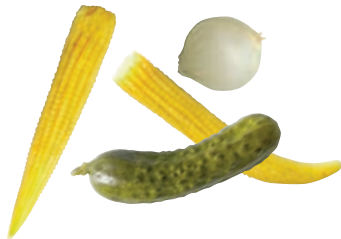

Raclette is an old farmer's recipe from the Wallis mountains, a real delicacy with Alpine cheese grilled with the heat of embers. Today everyone can make classic raclette quickly and easily using a TTM-Raclette oven.

To make it, you use one or two half-wheels of raclette cheese depending on the number of your guests. Just hold the cutting surface under the heat until the cheese begins to melt. The melted cheese is then scraped off directly onto a plate and served with boiled potatoes, baby onions and pickled gherkins. A heavy dash of ground pepper is considered the finishing touch for every raclette, and is of course sprinkled on individually by each person at the table.

By tradition, each guest begins to eat immediately while the cheese is still warm and does not wait until all have been served. Accompany this scrumptious meal with a fine, dry white wine. According to an old custom, it is the man of the house who makes the raclette.



Enjoy!

Assembly / Set-up

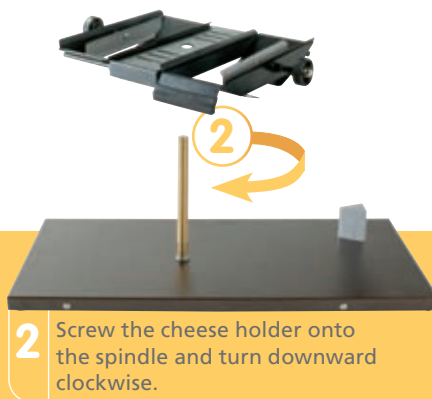
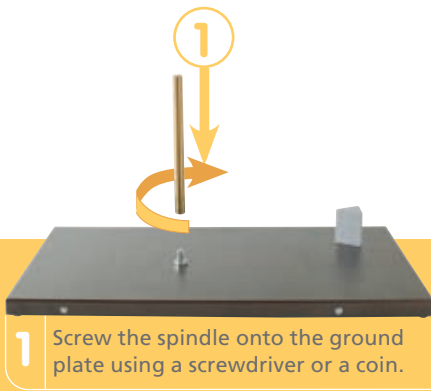

Cleaning

Only clean with a damp cloth. Rub the machine dry after cleaning. Never submerge the metal parts in water.

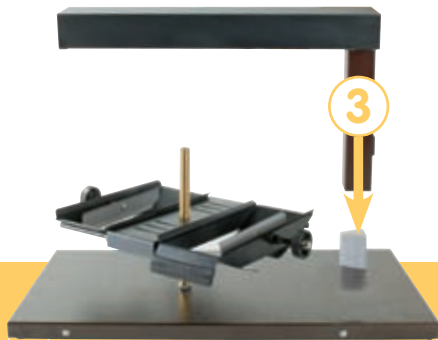

3 Place the heating arm with the column onto the aluminium bolt.



4 Attach the heating arm with the knurled screw, insert the power cable. A small amount of smoke can result during initial usage. This is normal and does not indicate any danger.

Lubricate the black metallic parts occasionally with cooking oil.

Preparing the Raclette



- 1** If necessary, clean the cheese rind by gently scraping it (do not cut off!).



- 2** Place the cheese onto the cheese holder.

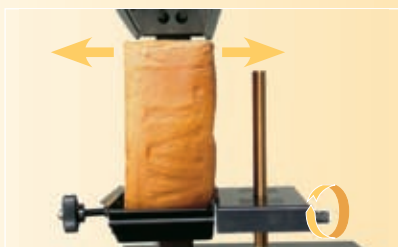

- 5** Position the cheese holder centrally under the heater by means of the knurled screws.



- 6** Turn the cheese holder around the spindle.



3 Clamp the cheese in position.

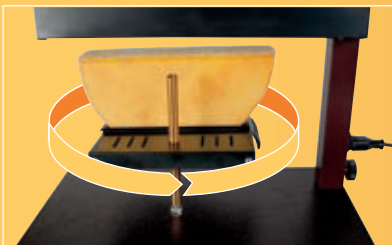

4 Turn the cheese upward to the heater (distance 2cm). Switch on: Set switch to 1 or connect cable





7 Lift the cheese holder into an angled position and scrape off onto the plate with the raclette knife (smooth side).



Tipp

A grilled crust forms on the edges after 4-5 raclettes each. Cut off this fine crust with the serrated side of the raclette knife and serve with a raclette (in French it's called "religieuse" ("religious raclette") because it tastes so heavenly!). Freeze remaining cheese or use it for gratins, sandwiches or as cheese slices. Large left-over pieces keep for up to 8 weeks in the refrigerator, small ones for 2-3 weeks.







Our classic appliances...

	Party	Party Caro	Racletta
			
Cheese	¼ round	¼ square	⅓ square
Power	600W	600W	600W
On-off-switch	No	Yes	No
Swivel arm	Yes	No	Yes

	Super	Evolène «Top range»-model
		
Cheese	2 x ½ round and square	2 x ½ round and square
Power	1000W	2 x 1000W
On-off-switch	Yes	2 x (1 per heater)
Swivel arm	Yes	2 x (1 per cheese)

Ambiance	POP	Zinal «Top range»-model	DS 2000
			
½ round and square	½ round and square	½ round and square	2 x ½ round and square
1000W	1000W	1000W	1000W
Yes	No	Yes	Yes
No	Yes	Yes	No

Trio	Gas Appliances		
	Easy-Gaz	Brio-Gaz	Balthasar
			
3 x ½ round	½ round and square	2 x ½ round and square	½ round and square
2 x 1000W	1.9 – 2.5 kW	2.6 – 3.4 kW	2.6 – 3.4 kW
2 x (1 per heater)	No	No	No
No	No	Yes	Yes





Raclette easy (without electricity or gaz)

	Twiny Cheese red	Twiny Cheese black	Twiny Cheese stainless steel
			
Heater	6 candles	6 candles	6 candles
Order number	No. 100.024	No. 100.025	No. 100.029



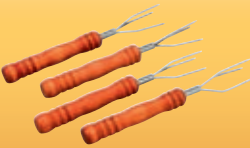

	Pico	Racly	Raclette à deux
			
Heater	3 candles	1 gel burner	2 gel burners
Order number	No. 100.033	No. 100.021	No. 100.026

Raclette accessories...

Profi	Chef	Support in stainless steel	Handle for cheese-holder
			
Knife to scrape off the cheese	With anti-stick coating	Long bracket for square cheeses	Heat protection made of rubber
No. 800.001	No. 800.071	No. 102.1032	No. 102.065

Holder for ½ cheese (round and square)	Holder for 2 x ½ cheese (round and square)	Potato fork	Brienz
			
With non-stick coating	With non-stick coating	4 forks with 3 prongs each	Wooden bucket to keep the potatoes warm
No. 101.052.1	No. 101.101.1	No. 800.070	No. 800.068

Safety Instructions

	Never let the appliance come into contact with water or other liquids. Danger of short circuiting!
	Only place onto secure surfaces. Minimum distance to the wall 30 cm.
	Never operate without cheese • Never use near easily flammable materials • Children may not use the appliance • Turn off the machine even when the heating of the cheese is briefly interrupted • Always position the cheese holder and clamping screw outside of the heat source when without cheese • Never place the machine on combustible materials (paper towels, etc.) • The spindle and the top of the heater get hot • Never touch the heater from below • Do not touch the machine for twenty minutes after turning it off • Without cheese the bottom of the appliance and the underlying surface become hot: keep away from combustible materials
	Disposal: The power cable must be disconnected from the machine. Follow the regulations of your residential community.





Garantie • Garantie

Garantie • Warranty

D: Wir leisten für dieses Gerät eine Garantie von 24 Monaten. Wir haften während dieser Zeit für alle Mängel, die auf Konstruktions- oder Materialfehler zurückzuführen sind, jedoch nicht für Selbstverschulden. Für die Ausführung einer Garantiarbeit ist diese Seite mit dem Apparat an uns zu senden. Die Garantie ist nur gültig mit Datum und Stempel des Verkäufers.

F: Nous accordons une garantie de 24 mois à partir de la date de vente. Pendant toute la période de garantie, nous répondons de toutes les pièces de l'appareil qui pourraient se révéler défectueuses à la suite d'un défaut de fabrication ou de matériel. Toutefois, nous ne répondons pas des dégâts causés par une mauvaise manipulation de l'appareil. Pour toute réparation sous garantie, veuillez nous renvoyer l'appareil accompagné de cette page. La garantie n'est valable que si elle est munie de la date de vente et du cachet du vendeur.

E: We provide a warranty of 24 months for this appliance. During this period, we are liable for all defects that can be attributed to construction and material defects but are not due to the fault of the claimant. Please send this page to us with the machine for warranty work to be performed. The warranty is only valid with the date and stamp of the seller.

Verkaufsdatum, date de vente, date of purchase: _____

Verkäufer, Vendeur, Retailer: _____



TTM 